

**DL7440/DL7480**  
**Digital Oscilloscope**

**OPERATION GUIDE**

---

## Foreword

---

Thank you for purchasing the DL7400 (DL7440/DL7480) Digital Oscilloscope. This operation guide is designed to bring first-time users quickly up to speed with the basic operations of the DL7400. There are two other manuals for the DL7400 in addition to this operation guide: the DL7400 User's Manual (IM701450-01E) that explains all of the functions of the instrument, and the Communications Interface User's Manual (IM701450-17E) that provides a more in-depth description of the instrument's communications functions. Please refer to all of these manuals when operating the instrument.

## Note

---

- The contents of this manual are subject to change without prior notice as a result of improvements in the instrument's performance and functions. Display contents illustrated in this manual may differ slightly from what actually appears on the screen.
- Every effort has been made in the preparation of this manual to ensure the accuracy of its contents. However, should you have any questions or find any errors, please contact your nearest YOKOGAWA representative as listed on the back cover of this manual.
- Copying or reproducing all or any part of the contents of this manual without the permission of Yokogawa Electric Corporation is strictly prohibited.
- A warranty card is included in the package. Please read it carefully, and do not lose it as a new one cannot be issued.
- The TCP/IP software or TCP/IP related documentation used for this software was developed or created using BSD Networking Software, Release 1 licensed from the Regents of the University of California at Berkeley.

## Trademarks

---

- Adobe, Acrobat, and PostScript are trademarks or registered trademarks of Adobe Systems Incorporated.
- Zip is a registered trademark of Iomega Corporation in the United States and/or other countries.
- The company and product names used in this manual are not accompanied by the trademark or registered trademark symbols (TM and ®).
- Other company and product names are trademarks or registered trademarks of their respective holders.

## Revisions

---

1st Edition: June 2003  
2nd Edition: April 2005

# Contents

---

Foreword .....	1
Flow of Operation .....	3
Names and Functions of Front Panel Controls .....	4
Parts of the Screen .....	7
Basic Key and Jog Shuttle Operation .....	10
Introduction to Main Functions .....	12
Working with the DL7400 .....	17
• Preparing for an Observation .....	17
• Displaying a Waveform on the Screen .....	19
• Changing Waveform Display Conditions .....	20
• Changing Trigger Settings .....	23
• Measuring a Waveform .....	25
• Zooming a Waveform along the Time Axis .....	26
• Printing and Saving a Waveform .....	27

# Flow of Operation

The chart below is provided to give first-time users an easy-to-understand glimpse of the overall flow of the DL7400's operation. It is not intended to describe the flow of operations exactly as they are presented in this manual. For details about specific items introduced in the pages within, refer to the corresponding chapter or section in the user's manual as indicated by the arrows (▶).

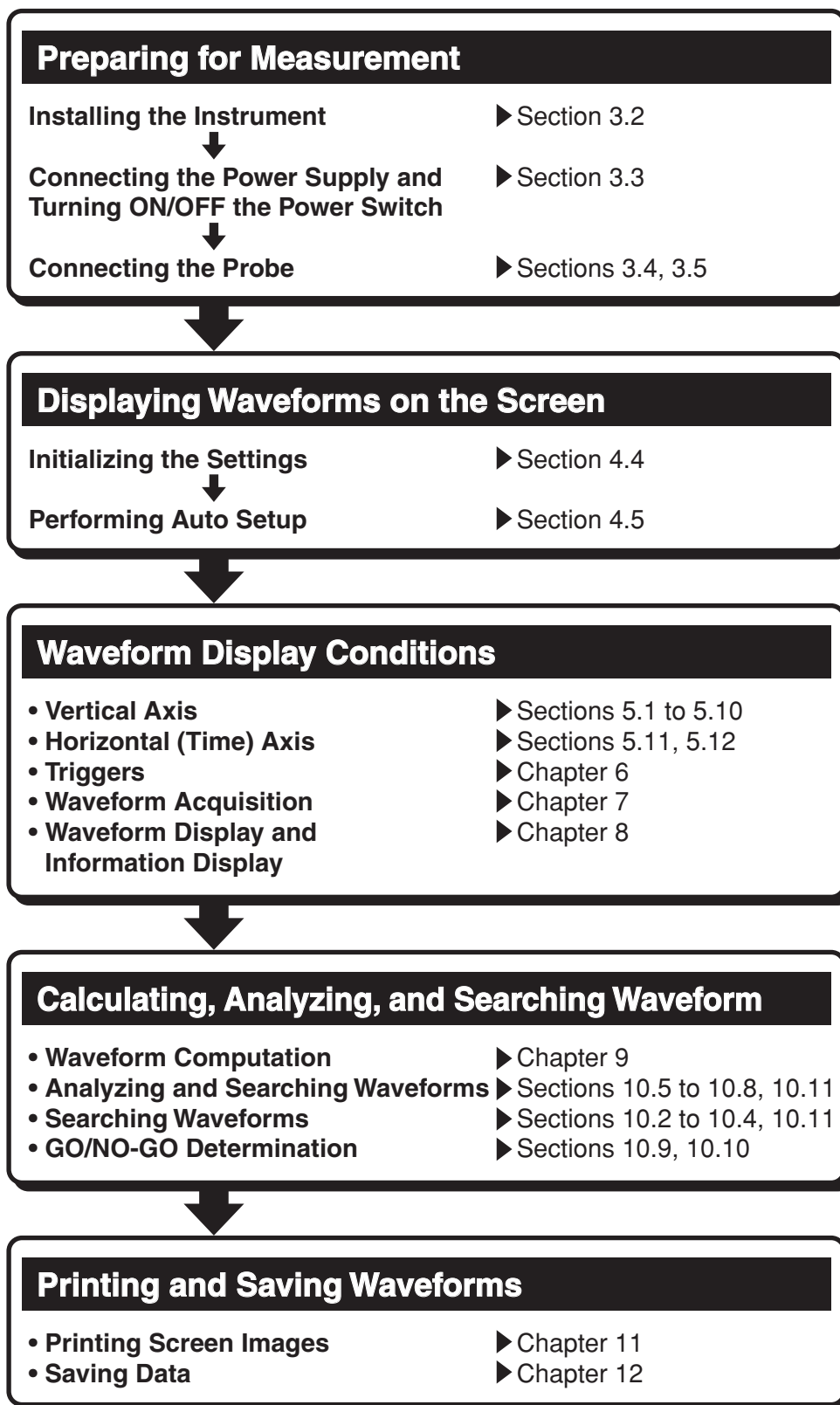

# Names and Functions of Front Panel Controls

This section introduces the names of the various keys and knobs that appear on the front panel, and provides a brief explanation of what functions they control. For details about specific items introduced in the pages within, refer to the corresponding chapter or section in the user's manual as indicated by the arrows (▶).

## Vertical Axis

**CH1 to CH8(4)\* keys** ▶ Sections 5.1 to 5.10  
Turns the corresponding channel ON/OFF, and displays a setting menu for the channel's vertical position, coupling, probe attenuation/current-voltage conversion ratio, offset voltage, bandwidth limit, vertical axis zoom, linear scaling, and waveform labels. Pressing a channel key displays the channel's menu. If you then turn the V/DIV knob, the V/DIV setting will apply to that channel. The indicator to the left of each channel key illuminates when the channel's display is ON.

\* The DL7440 has four channel keys, and the DL7480 has eight. Hereafter, the expression CH1 to CH8(4) will be used to mean channels 1 through 8 on the DL7480, or channels 1 through 4 on the DL7440.

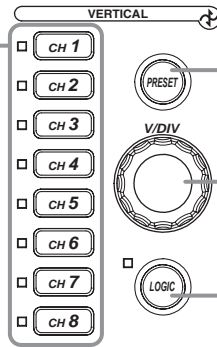

**PRESET key** ▶ Section 5.7  
Displays a menu for automatically setting the probe attenuation/current-to-voltage conversion ratio, V/div, offset voltage, trigger level and other items to CMOS or ECL signal values (or other desired values). Presets can also be assigned to all channels at once.

**V/DIV knob** ▶ Section 5.2  
Sets the vertical axis sensitivity\*. Before turning the knob, you can press a CH1 to CH8(4) key to select the channel and display its menu. If you change the vertical axis sensitivity setting while waveform acquisition is stopped, the new setting takes effect when you start waveform acquisition again.

\* In the probe attenuation ratio/current-to-voltage conversion ratio settings, the voltage axis sensitivity is set when setting the probe attenuation ratio, and the current axis sensitivity is set when setting the current-to-voltage conversion ratio.

**LOGIC key** ▶ Section 5.10  
Displays a menu for optional logic input settings such as display ON/OFF, display format, threshold level, and waveform level.

## Horizontal Axis

**(SHIFT +) ZOOM key** ▶ Sections 8.4, 10.4, and 10.11  
Displays a menu for waveform zoom settings. Pressing the ZOOM key after the SHIFT key displays a setting menu for waveform searching (the Search and Zoom function) and SPI signal analysis/search.

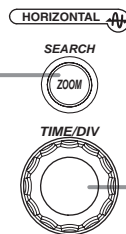

**TIME/DIV knob** ▶ Section 5.12  
Sets the horizontal axis (time axis) scale. If you change the setting while the waveform acquisition is stopped, the new setting takes effect when you start waveform acquisition again.

## Triggers

**TRIG'D indicator**  
Illuminates when a trigger has been activated.

**SIMPLE key** ▶ Sections 6.5 to 6.7  
Displays a menu for setting a simple trigger, which is usually the edge trigger. The indicator on the upper left of the SIMPLE key illuminates when the simple trigger is active.

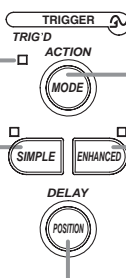

**(SHIFT +) MODE key** ▶ Sections 6.1, 6.16, and 7.6  
Displays a setting menu for trigger modes and sequential store. If you press the MODE key after the SHIFT key, a setting menu is displayed for the action trigger.

**ENHANCED key** ▶ Sections 6.8 to 6.15  
Displays a setting menu for enhanced triggers such as the pattern trigger or other complex triggers. The indicator on the upper right of the ENHANCED key illuminates when the enhanced trigger is active.

**(SHIFT +) POSITION key** ▶ Sections 6.2, 6.3  
Displays a setting menu for the trigger position. If you press the POSITION key after the SHIFT key, a setting menu is displayed for the trigger delay.

## Common Operations and Acquisition, Display, Computation, Analysis, and Searching

### (SHIFT +) DISPLAY key

► Sections 8.1 to 8.3, 8.5, and 8.7 to 8.10  
Displays a setting menu for display of waveforms and their information.  
If you press the DISPLAY key after the SHIFT key, a setting menu appears for X-Y display.

### SETUP key

► Sections 4.4, 4.5, and 12.1  
Displays an auto setup menu for automatically assigning values from the input signal to settings, the Initialize menu for restoring factory default settings, and the Store/Recall settings menu.

### ESC key

Use this key to close soft key menus and dialog boxes.

### MEASURE key

► Sections 10.6 to 6.8  
Displays a menu for automatic measurement of waveform parameters and statistical processing.

### CURSOR key

► Section 10.5  
Displays a setting menu for cursor measurement.

### HISTORY key

► Sections 10.1 to 10.3  
Displays a setting menu for displaying and searching waveforms using the History memory function. The key is also used to display and search sequentially stored waveforms.

### GO/NO-GO key

► Sections 10.9, 10.10  
Displays a setting menu for GO/NO-GO determination.

### (SHIFT +) MATH key

► Sections 9.1 to 9.9  
Displays a setting menu for waveform computations.  
If you press the MATH key after the SHIFT key, a setting menu is displayed for the phase shift.

### SHIFT key

Pressing the SHIFT key causes the SHIFT lamp above the key to illuminate, indicating that the instrument has entered SHIFT mode. When in SHIFT mode, the setting menus labeled in purple above various keys become available.

### RESET key

Restores a value changed using the jog shuttle to its original setting.

### SELECT key

Enters a value set using the jog shuttle.

### Jog shuttle

Used in many operations to select setting values and move cursors. The angle through which the shuttle ring is rotated determines the rate at which the setting values increment or decrement.

### Arrow keys (< >)

Changes the currently selected digit when entering values with the jog shuttle. Used to change setting values and move cursors.

### START/STOP key

► Section 7.1  
Starts/stops waveform acquisition according to the trigger mode. The indicator above the START/STOP key illuminates when waveforms are being acquired.

### ACQ key

► Sections 5.11, 7.2 to 7.5  
Displays a setting menu for the record length, acquisition mode, interleave mode, sampling rate, and time base during waveform acquisition.

## Printing Screen Images and Saving/Loading Data

### FILE key

► Sections 12.2, 12.3, 12.6 to 12.11, 12.13 to 12.16  
Displays a menu used when saving data to or loading data from a storage medium (internal storage media, external SCSI devices, or network drives). You can also use this key to display thumbnails of saved screen images.

### (SHIFT +) PRINT key

► Chapter 11  
Used to print screen images on the built-in printer, an external USB printer, or a network printer. If you press the PRINT key after the SHIFT key, a setting menu appears for printing screen images.

### (SHIFT +) IMAGE SAVE key

► Sections 12.12, 12.13  
Used to save screen images to storage media.  
If you press the IMAGE SAVE key after the SHIFT key, a setting menu appears for saving screen images to storage media. You can also use this key to display thumbnails of saved screen images.

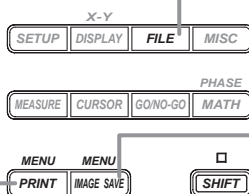

## ■ Calibration, Ethernet Communications, and Other Operations ■

**MISC key** ▶ Sections 3.7, 4.6, 6.17, 12.4, 16.3, 16.4, and chapters 13 and 15 of the Communications User's Manual  
 Displays a menu for settings related to the date/time, calibration, trigger gate, SCSI ID number, Ethernet communications, message language, click sound ON/OFF, USB keyboard language, use of offset voltage measurement/computation results, screen colors/brightness, backlight, self test, and remote control. It can also be used to display settings and the system status (options installed on the unit, firmware version etc.).

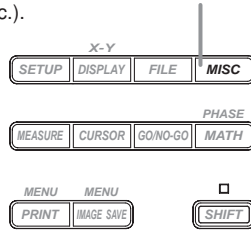

**CLEAR TRACE key** ▶ Section 8.6

Clears snap shot waveforms and accumulated waveforms.

**SNAP SHOT key** ▶ Section 8.6

Displays a non-updating copy of the currently displayed waveform on the screen in white (default setting).



**HELP key** ▶ Section 4.7

Turns the help window, which provides explanations of operations, ON and OFF.

# Parts of the Screen

This section introduces the menus and symbols appearing on the DL7400 screen. For details about specific items introduced in the pages within, refer to the corresponding chapter or section in the user's manual as indicated by the arrows (▶ or ●●●▶).

## Common Parts of the Screen

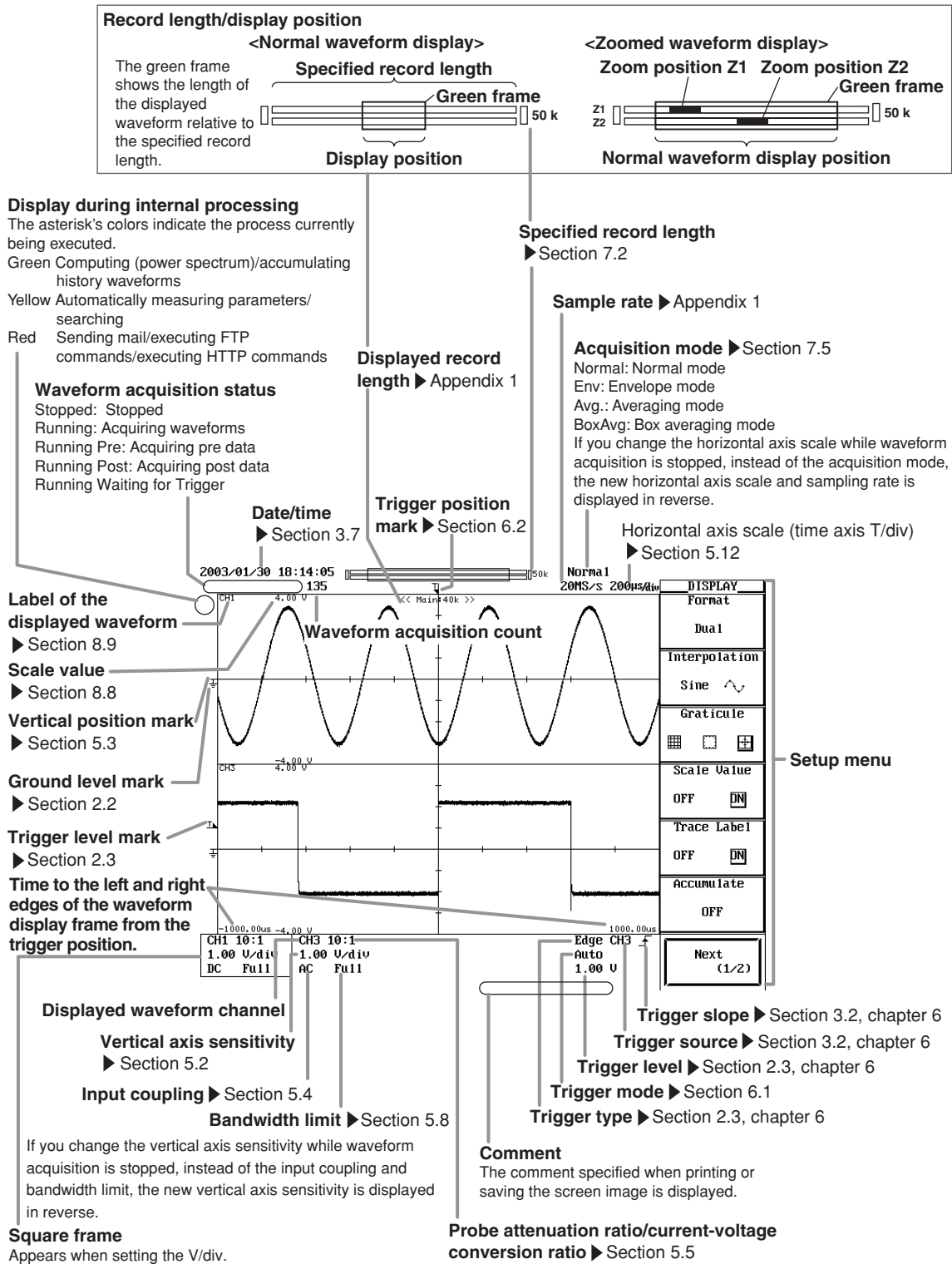



## Screen When Displaying Zoomed Waveforms

●●●▶ User's manual section 8.4, "Zooming the Waveform"

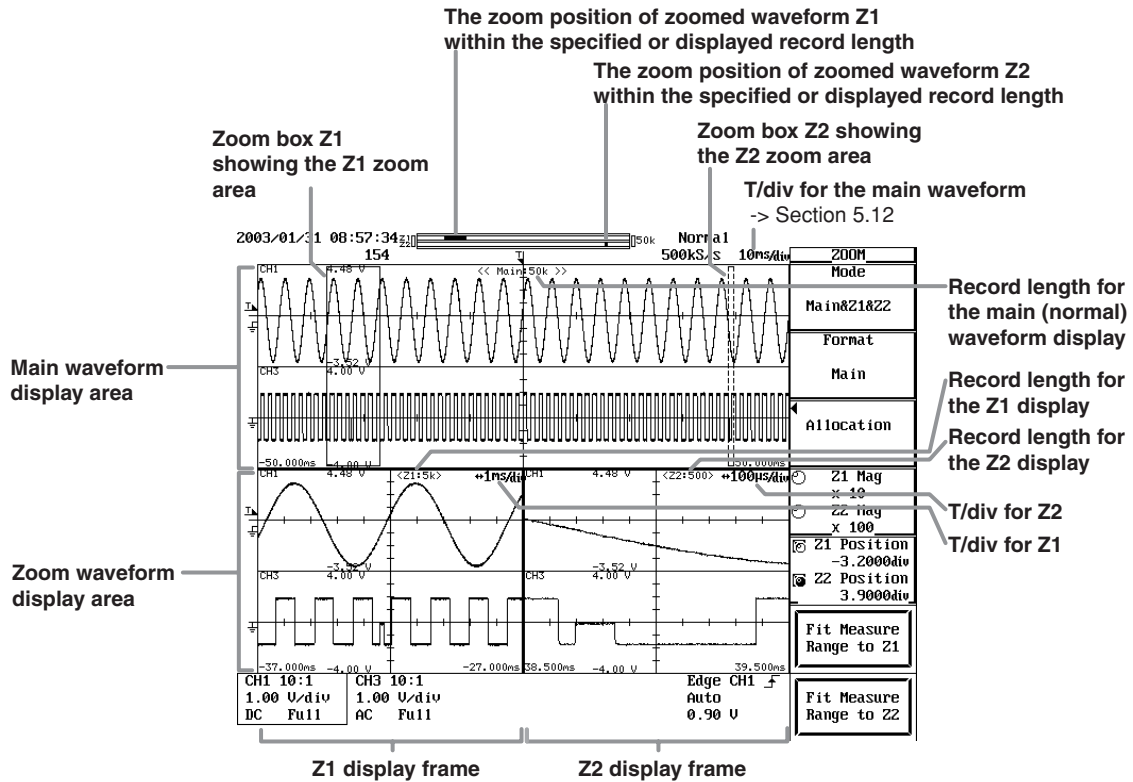

## Screen When Displaying Logic Waveforms

●●●▶ User's manual section 5.10, "Turning ON/OFF the Logic Input and Setting the Threshold Level"

●●●▶ User's manual section 8.1, "Setting the Display Format"

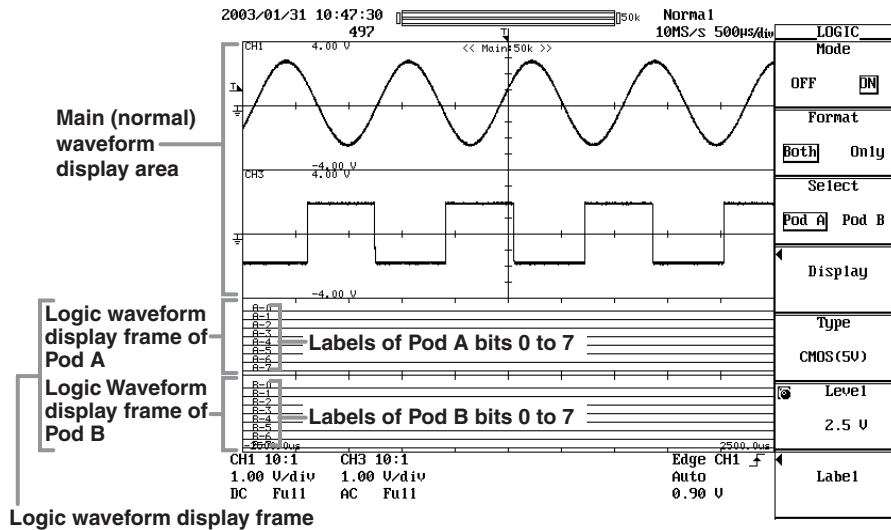

**Logic waveform display frame**  
As in this example, you can display normal waveforms and logic waveforms simultaneously, or one or the other on the entire screen.

# Screen When Displaying X-Y Waveforms

●●●▶ User's manual section 8.5, "Displaying X-Y Waveform"

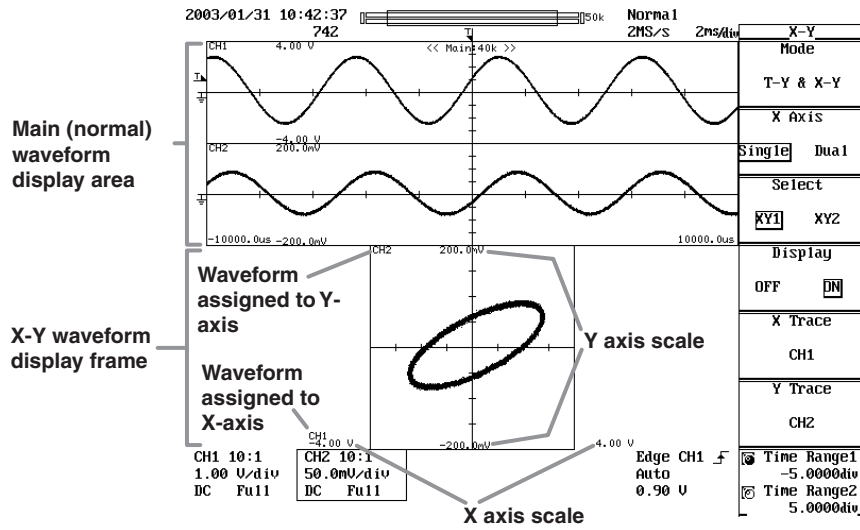

# Basic Key and Jog Shuttle Operation

This section explains the basics of using the keys and jog shuttle for entering settings on the DL7400.

## Basic Key Operation

### Working with the Setup Menu

**ACQ menu** (the menu displayed by pressing the ACQ key)

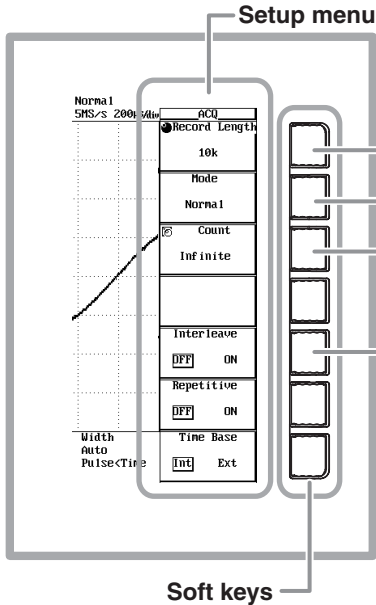

**Selecting Items by using the jog shuttle** (in menus with the ● ○ and icons)  
 Press the soft key to enable the jog shuttle (●:enabled, ○:disabled).  
 Turn the jog shuttle to change the setting.

**Selecting Items by displaying a selection menu**  
 Press a soft key to display the corresponding selection menu.  
 Press the soft key corresponding to the desired selection.

**Entering values by using the jog shuttle** (in menus with the [ ] and icons)  
 Press the soft key to enable the jog shuttle ([ ]:enabled, [ ]:disabled).  
 Turn the jog shuttle to select a value. Use the arrow key to change the selected digit.

**Selecting an item among displayed selections**  
 Each time you press the soft key, the selection item changes.  
 The selected item is highlighted.

**Note**

**How to display the setup menu for the functions labeled in purple**  
 Characters Press the SHIFT key (causing the SHIFT indicator above the key to illuminate), then press a key labeled with purple characters to display the corresponding menu.

### Working with Dialog Boxes

**The delay setting dialog box**

(Appears when pressing the MEASURE key, then turning the mode ON and pressing the Delay Setup soft key in the setup menu that is displayed.)

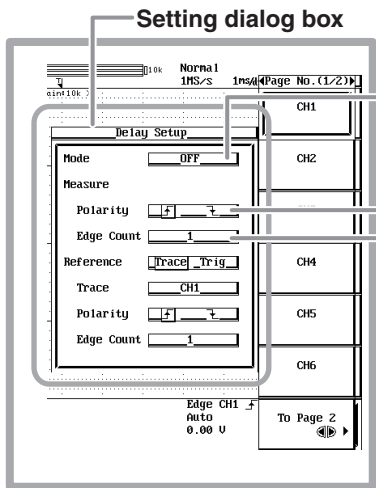

Use the jog shuttle to select the desired setting.

Press the SELECT key to display the selection menu.  
 Turn the jog shuttle to move the cursor to the desired setting.  
 Press the SELECT key to enter the desired setting.

Each time you press the SELECT key, the selection item changes.

Press the SELECT key to display the numerical value input box.  
 Turn the jog shuttle to select a value.  
 Use the arrow key to change the selected digit.

**When mode is selected**

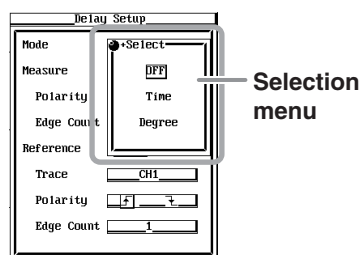

**When edge count is selected**

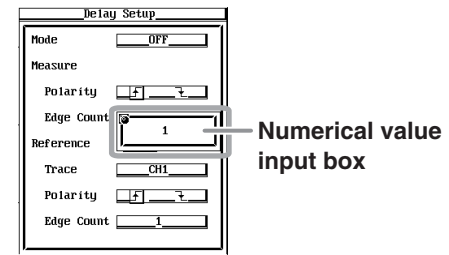

**Note**

To close a setup menu or dialog box from the screen, press the ESC key.

## Basic Jog Shuttle Operation

### Selecting an Item

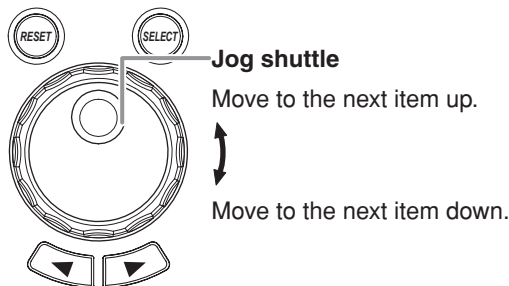

### Entering Numerical Values

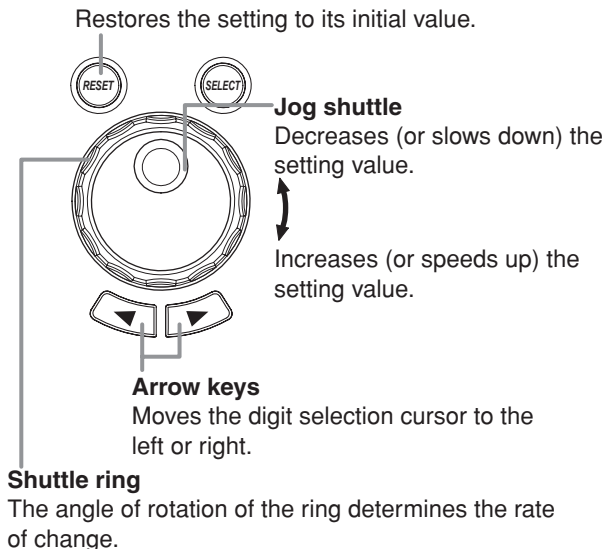

### Tips

#### Using a USB Mouse

Introduction to main functions ● ● ● ▶ [User's manual section 4.3, "Operating the DL7400 Using a USB Keyboard or USB Mouse."](#)

If you connect a USB mouse to the USB PERIPHERAL connector on the rear panel of the instrument, you can use the mouse to perform the same operations available with the front panel keys.

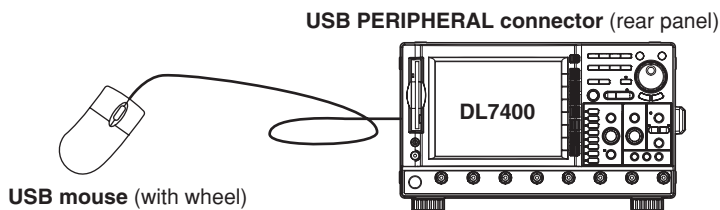

**Top menu**  
Right click in the display (waveform display frame) to display the top menu containing all the names of the front panel keys.

**Sub menu**  
A sub menu is displayed when clicking on a top menu item accompanied by an arrow (>).

**Pointer**  
Move the pointer to the desired item, click it, and the corresponding setup menu appears.

If you move the mouse pointer to this position, the pointer changes from a mouse pointer to a hand with a wheel. In this mode, if your mouse has a wheel you can use it to change the V/div setting.

If you move the mouse pointer to this position, the pointer changes from a mouse pointer to a hand with a wheel. In this mode, if your mouse has a wheel you can use it to change the T/div setting.

# Introduction to Main Functions

## Trigger

● ● ● ►  User's manual chapter 6, "Triggers"

There are two main categories of triggers: simple triggers and enhanced triggers.

### Simple triggers

#### Edge trigger

If the signal input to the measurement input terminal passes through the specified trigger level (on the rising or falling edge, or both edges), the trigger activates.

#### External trigger

If the signal input to the EXT TRIG IN terminal passes through the specified trigger level (on the rising or falling edge, or both edges), the trigger activates.

#### Commercial power trigger

A trigger activates on the rising or falling of the waveform from the commercial power being supplied to the DL7400.

### Enhanced triggers

#### A->B(N) trigger

A trigger activates the Nth time condition B becomes true after condition A becomes true.

#### A Delay B trigger

After condition A becomes true, a trigger activates once condition B becomes true after a specified time has elapsed.

#### Pattern trigger

A trigger activates when all of the trigger conditions from several trigger sources\* are met/not met.

#### Width trigger

A trigger activates depending on whether the conditions became true or not for a shorter or longer duration than a specified reference time.

#### OR trigger

A trigger activates when at least one of the trigger conditions from several trigger sources is met.

#### Window trigger

A trigger activates when a trigger source enters or exits a "window" specified by two voltage levels.

#### TV trigger

A trigger activates on the video signal being input to CH1.

#### Logic trigger

A trigger activates on a logic signal.

\* A trigger source is a signal to which trigger activation conditions are applied.

## History Memory

● ● ● ►  User's manual section 10.1, "Displaying History Waveforms"

When measuring waveforms, numerical data is being loaded into the acquisition memory, and that data can be viewed on the DL7400 screen as a waveform. When taking continuous measurements, even if you stop measurement when you see an abnormal waveform, the waveform usually scrolls off the screen by the time measurement stops, preventing you from viewing it carefully. But with the history memory function, you can display past waveform data that has been loaded into the acquisition memory while measurement is stopped. You can displayed a specific waveform from among a maximum of 4096 "history waveforms." Also, you can search for history waveforms that pass (or do not pass) through a specified search zone. For details on this function, see section 10.2, "Searching the History Waveforms Using Zones (History Search)" in the user's manual.

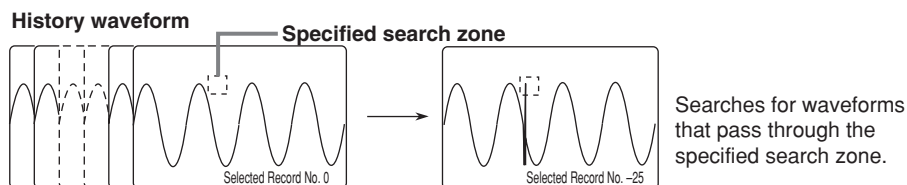

## Zooming a Waveform along the Horizontal (Time) Axis

●●●▶ User's manual section 8.4, "Zooming the Waveform"

You can expand (zoom) a displayed waveform along the time axis. Two areas of a waveform can be zoomed at the same time. This function is useful when you want to observe one part of a waveform in detail that was acquired over a long period of time. You can specify the area to be zoomed or the zoom position (position of the zoom box).

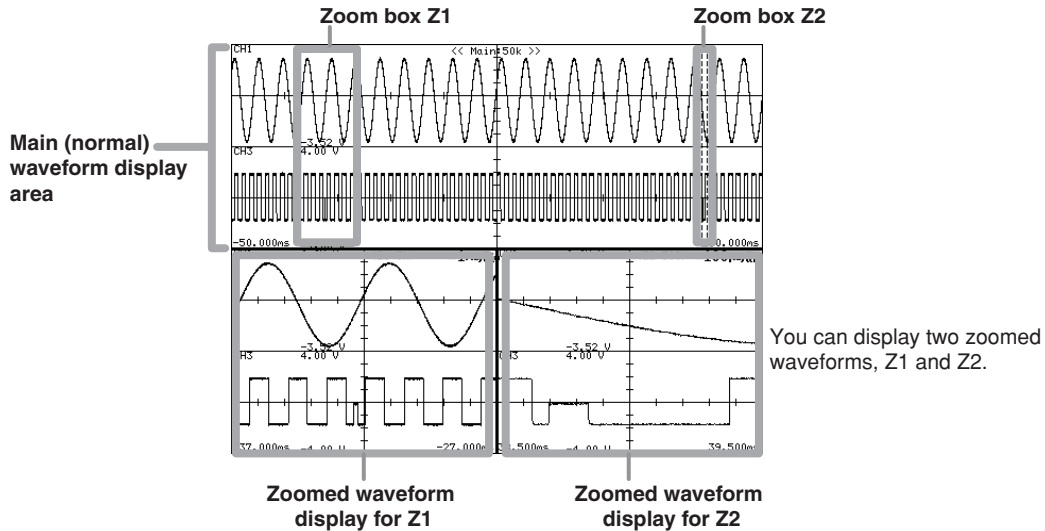

## X-Y Waveform Display

●●●▶ User's manual section 8.5, "Displaying X-Y Waveforms"

This function takes the signal level of the specified waveform assigned to the X-axis (horizontal axis), and the signal level of another waveform assigned to the Y-axis (waveform for which display is ON), and displays the relationship between the two. You can observe an X-Y waveform and the normal T-Y waveform (waveform based on the time axis and signal level) simultaneously. Up to two X-Y waveforms can be displayed on the screen.

## Waveform Computation

●●●▶ User's manual chapter 9, "Waveform Computation"

The following operations are available: arithmetic (+, -, x), binarization, inversion, differentiation/integration, phase shift, power spectrum computation (FFT). Instruments equipped with the user-defined math option (/G2) can also perform a second computation chosen from a wide selection of functions including trigonometric, differential, integral, square root, digital filtering, six types of FFT functions.

**Math definition dialog box**  
Enter the desired equation using the keyboard displayed in the dialog box. Up to 55 characters can be used in the equation.

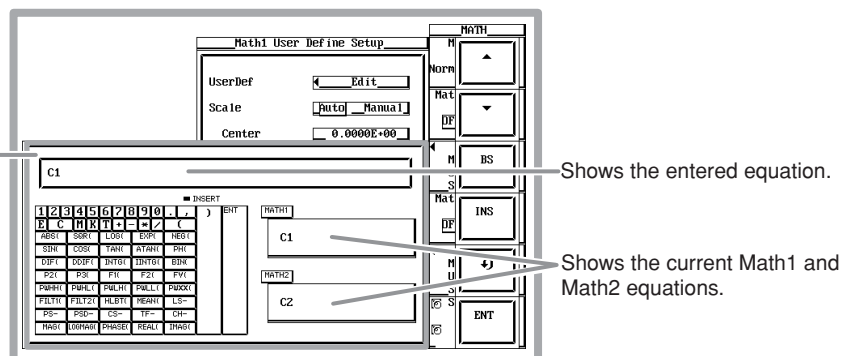

## Search and Zoom

●●●▶ [User's manual section 10.4, "Searching Waveforms Using the Search and Zoom Function"](#)

You can search saved waveforms and zoom-display those that match the search criteria. The following five search methods are available.

<p><b>Edge</b></p> <p>Performs a search based on the number of times that a waveform falls below or above (rising/falling) a specified level.</p>	<p><b>Serial pattern</b></p> <p>Performs a search based on whether the serial status pattern of the waveform (the status pattern of the waveform that changes over time) is High(H)/Low(L)/Don't care(X) and whether it is the same as a specified pattern.</p>	<p><b>Parallel pattern</b></p> <p>Performs a search based on whether the parallel status pattern of the waveform (the status pattern of the waveforms at the same point in time) is High(H)/Low(L)/Don't care(X) and whether it is the same as a specified pattern. You can also search by each bit of a logic signal.</p>
<p><b>Pulse width</b></p> <p>Searches for waveform pulses lying above or below a specified level whose widths are of shorter or longer duration than a specified time.</p>	<p><b>Auto scroll</b></p> <p>The zoom position automatically moves in the specified direction. You can watch the zoomed waveform as it scrolls, then stop it at any desired position.</p>	

## Analyzing or Searching SPI Signals

●●●▶ [User's manual section 10.11, "Analyzing and Searching SPI Signals"](#)

SPI (serial peripheral interface) is an interface developed by Motorola. In this system, data is transferred using three signal wires: clock signal, output data, and input data. By adding a chip select signal (CS), a master device can control output data from a slave device. Data is synchronized to the clock signal and transmitted in units of bytes (8-bits). The DL7400 analyzes and searches these SPI signals in single-byte units.

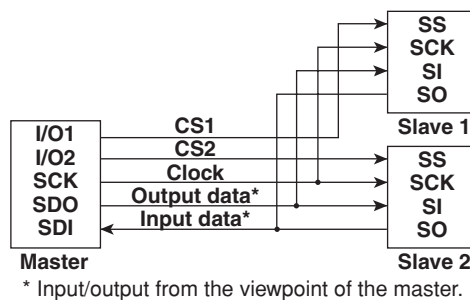

## Cursor Measurements

●●●▶ [User's manual section 10.5, "Making Cursor Measurements"](#)

You can place cursors on a waveform to display the measured values at the points where the cursor intersects with the waveform. There are four types of cursor available: horizontal, vertical, marker, and angle cursor.

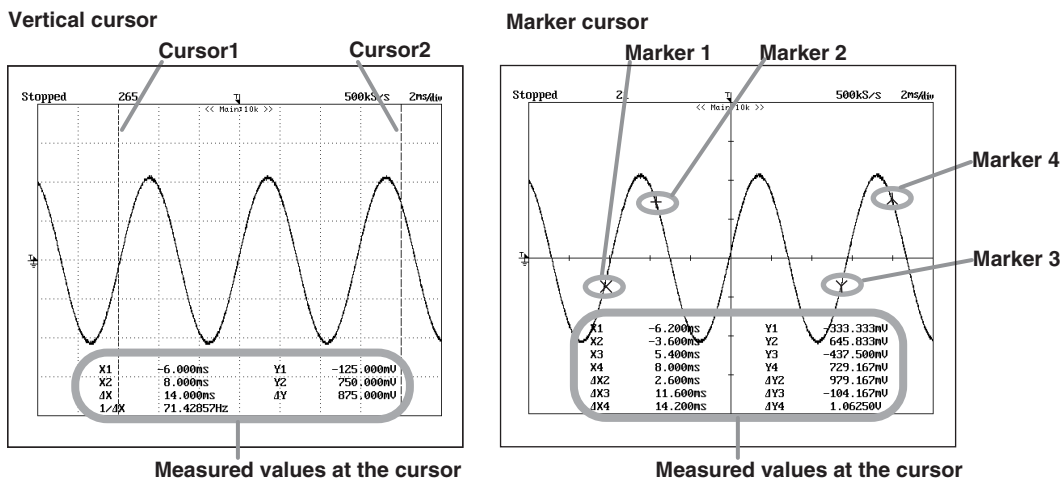

## Automatic Measurement of Waveform Parameters

● ● ● ▶ User's manual section 10.6, "Automatic Measurement of Waveform Parameters"

This function automatically measures certain properties of a waveform such as the maximum level and frequency. There are 27 parameters that can be measured (including between-waveform delay). Up to 12 of those parameters can be displayed on the screen. From all waveforms, up to 24000 data items total can be saved to a storage medium.

**Measured items related to the vertical axis: 10**

**Measured items related to the time axis: 12**

**Measured items related to the area: 4**



### Delay between waveforms

Measured items having to do with the time difference between the rising and falling of the target waveform relative to a reference waveform or trigger point.

## Statistical Processing

● ● ● ▶ User's manual section 10.7, "Performing Statistical Processing of the Measured Values of Waveform Parameters"

The following five results of statistical processing are performed on the same two measured items from automatic measurement of waveform parameters.

- Max** (maximum value)
- Min** (minimum value)
- Avg** (average)
- Sdv** (standard deviation)
- Cnt** (count, or the number of measured values on which statistics are taken)

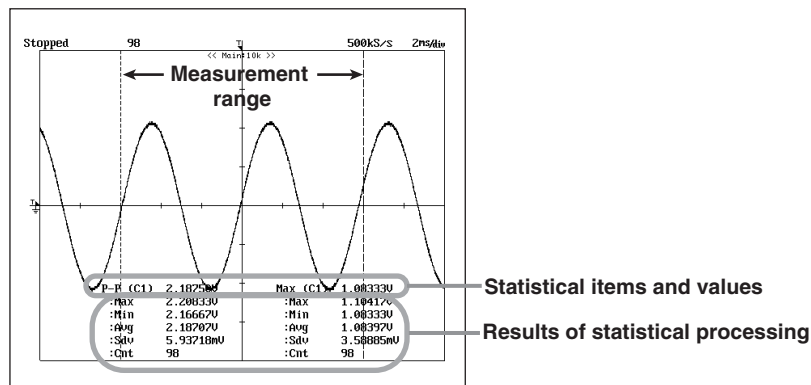

The following three types of statistical processing are available.

### Normal measurement/statistical processing

During measurement, all waveform data acquired up to the current time are measured for the selected measurement item and statistics are calculated.

### Measurement per cycle/statistical processing within the measurement range



Waveforms are delimited every cycle from the left side of the screen to the right (oldest to youngest), then each cycle is measured for the selected measurement item and statistics are calculated.

### Measurement and statistical processing of history waveforms

History waveforms are measured for the selected measurement item, and statistics are calculated. Measurement and statistics are taken starting with the oldest waveforms.



## GO/NO-GO Determination

- ● ● ▶  User's manual section 10.9, "Performing GO/NO-GO Determination Using Zones"
- ● ● ▶  User's manual section 10.10, "Performing GO/NO-GO Determination Using Measured Waveform Parameters"

This function determines whether a waveform enters or does not enter a specified range, and then performs (GO) or does not perform (NO-GO) a certain action. Determinations are made by specifying a zone on the on-screen waveform, or specifying a waveform parameter range. The GO/NO-GO actions include sounding a buzzer, saving data, printing a screen image, and sending an e-mail message (with the /C10 option installed).

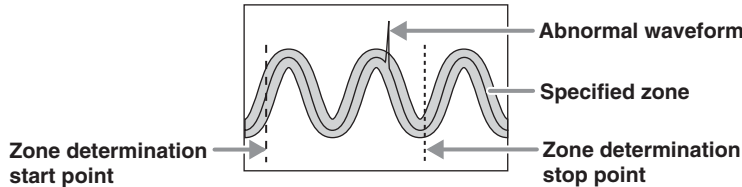

## Snapshot

- ● ● ▶  User's manual section 8.6, "Taking Snapshots and Clearing Traces"

When not in Single or Single(N) mode, the displayed waveform is periodically updated or displayed in roll mode. Using the Snapshot function, you can temporarily freeze a waveform on the screen that would ordinarily be lost when the screen is updated. Snapshot waveforms are displayed in white, allowing you to easily compare them with the updated waveforms. Furthermore, you can save snapshot waveforms to a memory medium, or print them out as screen images.

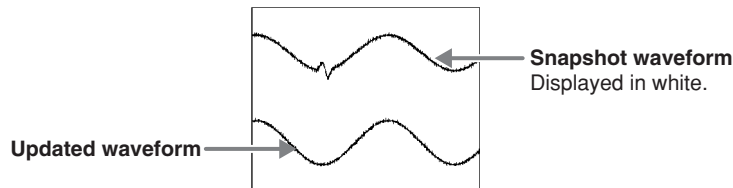

## Ethernet Communications

- ● ● ▶  User's manual chapter 13, "Ethernet Communications (Optional)"

You can transmit data or control the DL7400 using the Ethernet (available with the /C10 option).

### Saving and loading data to and from a network drive

You can save or load data and screen images to and from an FTP server\* on a network in the same way that you can do so using the internal storage medium, external SCSI device, or USB storage device.

\* A PC or workstation running the FTP server function

### Printing to a network printer

Screen images can be printed to a network printer in the same manner as they are printed to the built-in printer (optional) or USB printer.

### Sending mail

You can have the DL7400 send a mail at regular intervals containing its current settings and measured values. You can also have mail sent based on a GO/NO-GO determination or upon activation of an acquisition trigger that contains the trigger time and other information.

### Accessing the DL7400 from a PC or workstation

You can access the DL7400 from any FTP client\* on the network, and obtain files from the DL7400 internal storage medium, external SCSI device, or USB storage device.

\* A PC or workstation running the FTP client function

### Web server

You can set up the DL7400 as a Web server. From the DL7400 Web page, you can transmit files, monitor the displayed waveform, perform basic setting operations on the DL7400, and obtain waveform data.

# Working with the DL7400

This section provides an example of how you can observe a probe compensation signal being output from the DL7400.

## Preparing for an Observation

### Connecting the Power Supply

●●●▶  User's manual section 3.3, "Connecting the Power Supply and Turning ON/OFF the Power Switch"



**Before connecting the power supply, you must read the warnings in the user's manual listed in section 3.3, "Connecting the Power Supply and Turning ON/OFF the Power Switch."**

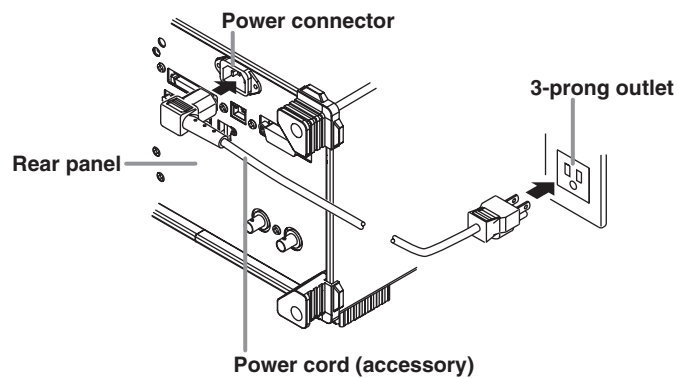

Rated supply voltage:	100 to 120 VAC/200 to 240 VAC
Permitted supply voltage range:	90 to 132 VAC/180 to 264 VAC
Rated power supply frequency:	50/60 Hz
Permitted power supply frequency range:	48 to 63Hz

### Turning the Power Switch ON and OFF

●●●▶  User's manual section 3.3, "Connecting the Power Supply and Turning ON/OFF the Power Switch"

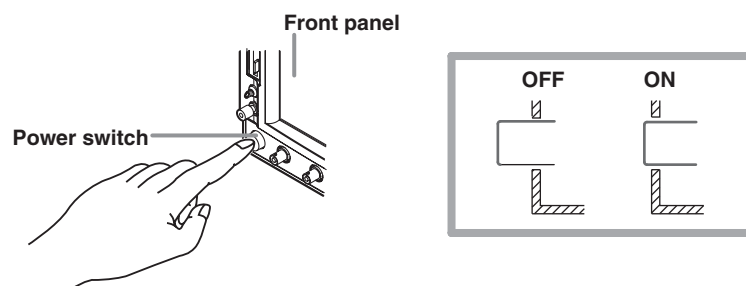

## Connecting the Probe

● ● ● ▶ □ User's manual section 3.4, "Connecting the Probe"

● ● ● ▶ □ User's manual section 3.5, "Compensating the Probe (Phase Correction)"



Before connecting the probe, you must read the warnings in the user's manual listed in section 3.5, "Compensating the Probe (Phase Correction)."

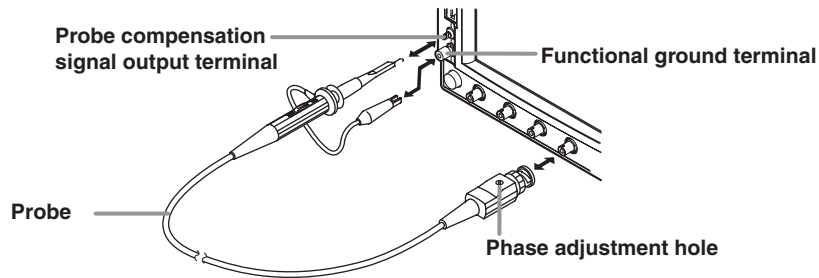

### Note

- For instructions on how to connect a logic probe, see section 3.6.
- When actually making waveform observations using the probe, you must follow the procedures in the user's manual for probe phase correction (section 3.5), and calibration (section 4.6). Failure to use the probe correctly will result in incorrect waveforms.

# Displaying a Waveform on the Screen

This section explains how to perform convenient, basic setting initialization and autoseup when you want to display common repeating waveforms such as sine waves and square waves.

## Initializing Settings

●●●▶ User's manual section 4.4, "Initializing Settings"

The procedure below restores the settings that are controlled using the front panel keys to their factory default values. If this is your first time to use the instrument the procedure is not necessary, but performing the procedure now will help you remember it for future reference. This initialization procedure is also useful when reentering settings to match the input signal.

**SETUP** — **1** Press the SETUP key.

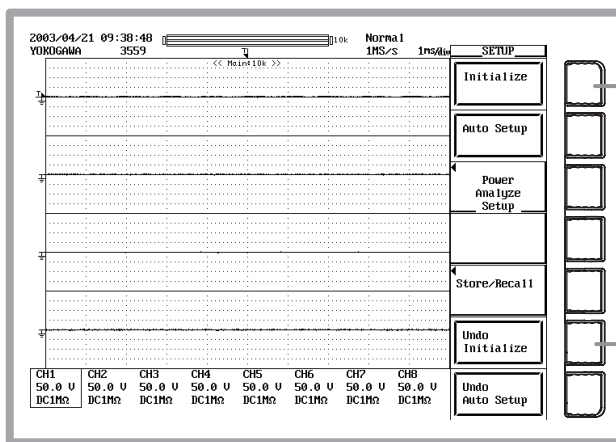

**2** The initialization executes.

To restore the settings prior to initialization, press this button.

### Note

- After initialization, display for all channels is turned ON, and the instrument enters START status.
- Items that are not subject to initialization using the soft key procedure are the following.

**The date/time setting, communication settings, stored settings, the language setting, and the SCSI ID setting.**

To initialize all settings but the date/time setting, perform the procedure below. Note that settings cannot be restored after this procedure. Turn the power switch to the DL7400 ON while pressing the RESET key.

## Auto Setup

●●●▶ User's manual section 4.5, "Auto Setup"

You can automatically enter vertical axis, horizontal axis, and trigger settings according to the input signal. This function is useful when you just want to quickly display the signal in order to determine what kind of signal it is and what sort of settings might be required to measure it.

**SETUP** — **1** Press the SETUP key.

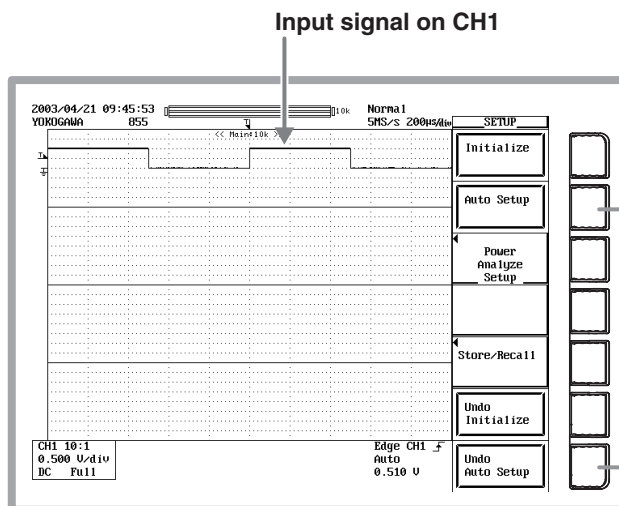

**2** Auto setup executes.

To restore the settings prior to auto setup, press this soft key.

### Note

- When you execute auto setup, only the display of the channel on which the signal is being input is ON.
- The waveforms on which auto setup can be performed must have the following properties:  
Frequency: approximately 50 Hz or higher  
Absolute value of input voltage: max. value of 20 mV (1:1) or more  
Type: repeating wave (non-complex)

# Changing Waveform Display Conditions

This section explains how to split the screen, and how to change settings such as the voltage or vertical axis sensitivity and vertical position, or the time or horizontal axis.

## Setting the Screen Divisions to Single

●●●▶ User's manual section 8.1, "Setting the Display Format"

The default number of screen divisions is four (Quad). In this case we only want to observe channel 1 so we change the setting to Single (1 screen).

**DISPLAY** — **1** Press the Display key.

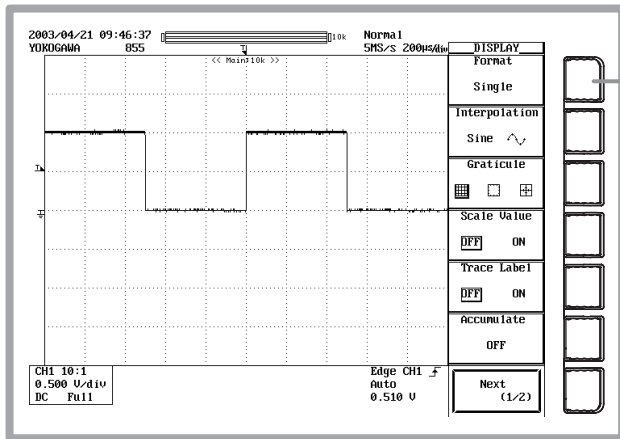

**2** Open the selection menu, then choose Single.

## Changing the Voltage Axis Sensitivity Setting from 0.5 V/div to 0.2 V/div

●●●▶ User's manual section 5.2, "Setting V/div"

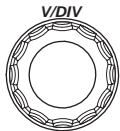

**1** Turn the T/div knob clockwise to set the voltage axis sensitivity to 0.2 V/div.

One part of the waveform goes out of view due to the rise in the voltage axis sensitivity.

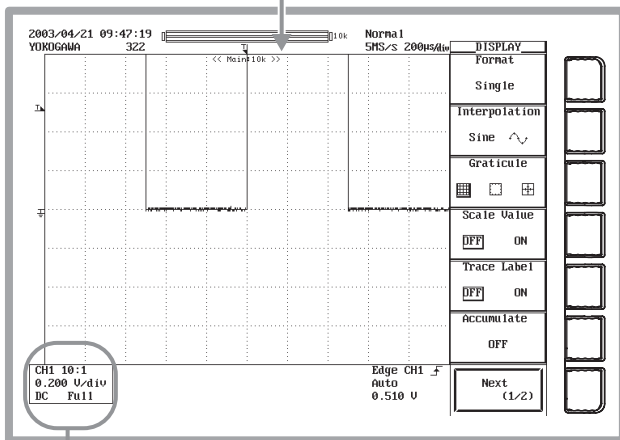

The voltage axis sensitivity setting for CH1

## Bringing the Waveform's Entire Amplitude into View by Lowering the Vertical Position

● ● ● ► User's manual section 5.3, "Setting the Vertical Position of the Waveform"

**CH 1** — **1** Press the CH1 key.

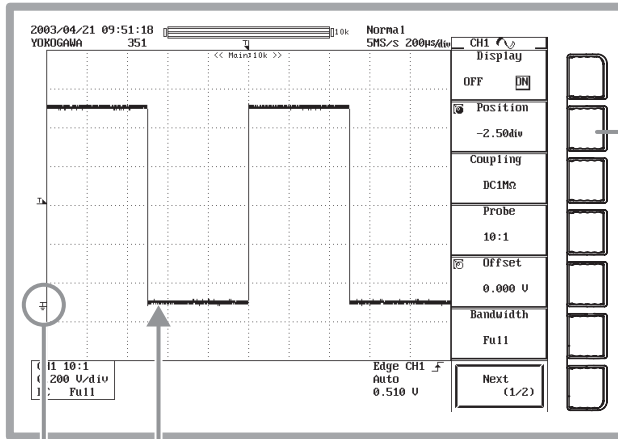

**2** Turn the jog shuttle counterclockwise to set Position to -2.50 div.

Lowering the vertical position allows the entire amplitude of the waveform to be displayed.

The ground level mark is also moved.

## Changing the Time Axis Setting from 200 $\mu$ s/div to 100 ms/div

● ● ● ► User's manual section 5.12, "Setting T/div"

The time axis setting is the setting for the amount of time per grid division. If you slow (increase the value of) the time axis setting, the display is updated according to triggers, so the instrument changes from update mode to roll mode in which the waveform scrolls from the right to left side of the screen. Roll mode is useful when you want to observe signals with long periods or signals that change slowly.

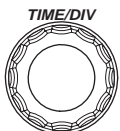

**1** Turn the TIME/DIV knob counterclockwise to set the time axis setting to 100 ms/div.

Time axis setting on CH1

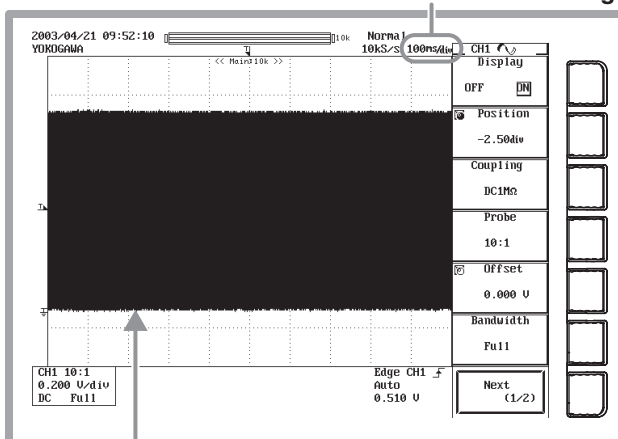

Roll mode display

# Changing the Time Axis Setting from 100 ms/div to 500 $\mu$ s/div

●●●▶  User's manual section 5.12, "Setting T/div"

The display reverts from roll mode back to update mode, and five periods worth of the waveform is displayed.



**1** Turn the TIME/DIV knob clockwise to set the time axis setting to 500  $\mu$ s/div.

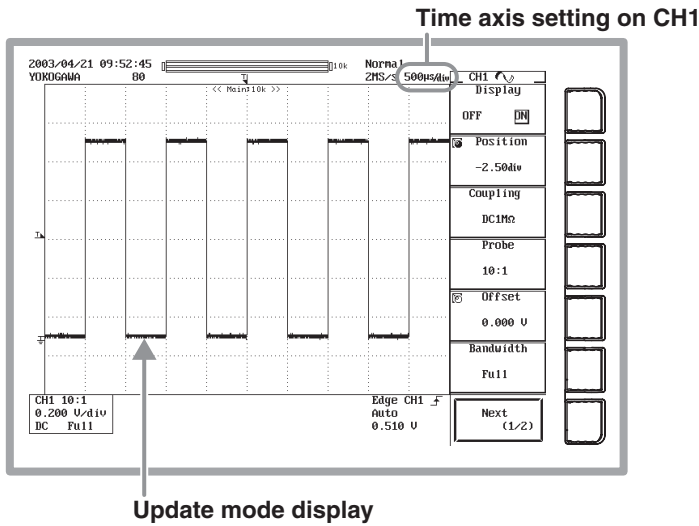

## Changing Trigger Settings

Trigger settings determine which waveforms of the loaded measurement signals to display, and at which times. The following are the most commonly used trigger settings.

### Trigger Types

The two main types of triggers are simple triggers and enhanced triggers. For details, see page 12 of this guide.

### Trigger Source

A trigger source is a signal to which trigger activation conditions are applied.

### Trigger Slope

The slope of a signal is its movement from a low level to a high level (rising), or from a high level to a low level (falling). When specifying the slope as one of the trigger conditions, it is called the trigger slope. The point at which the slope of the trigger source passes through the trigger level is called the edge.

### Trigger Level

This is the level through which the trigger source must pass to activate the trigger. With a simple trigger such as an edge trigger (see page 12 of this guide), the trigger activates if the level of the trigger source passes through a trigger level specified in advance.

### Trigger Mode

The trigger mode determines the conditions (such as timing and the number of times) at which the waveform display is updated. If you execute auto setup, the trigger mode is set to auto mode. Five trigger modes are available. For details, see section 6.1 of the user's manual, "Selecting the Trigger Mode."

### Trigger Position

When waveform acquisition is started, triggers are activated according to the trigger conditions, and the waveforms loaded into acquisition memory are displayed. By moving the trigger position on the screen, you can change the ratio of data that is displayed before (pre data) and after (post data) the trigger was activated. The initial setting is 50.0% (center screen).

If you initialize the settings or execute auto setup, the trigger type is set to simple (trigger source: CH1, edge trigger). Edge triggers activate based on the rising, falling, or both, of one input signal. In the procedure below, the trigger type is left as-is (edge trigger), and the method for changing the trigger slope, trigger mode, and trigger position settings is explained.

## Changing the Trigger Slope from Rising to Falling

●●●▶  User's manual section 6.5, "Setting the Edge Trigger (SIMPLE)"

**1** Press the SIMPLE key.

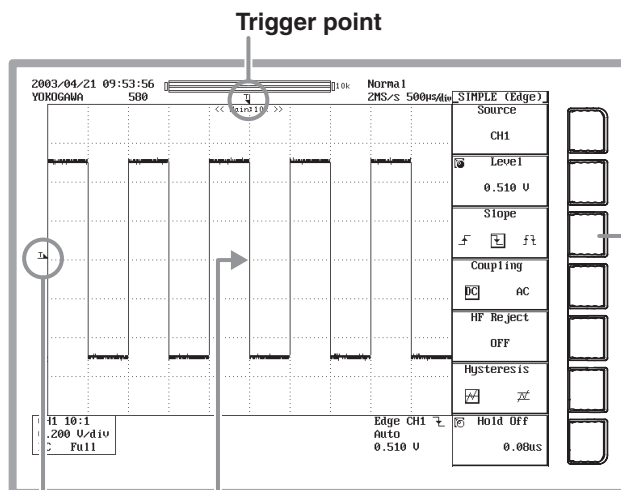

**2** Press the soft key to select  $\nabla$  (Falling).

The trigger activates on the falling edge.

Trigger level mark



## Shifting the Trigger Position to the Left by Two Divisions

● ● ● ▶ User's manual section 6.2, "Setting the Trigger Position"

By shifting the waveform to the left by just 2 div, the part of the waveform after the trigger (post trigger) becomes much easier to see.

- 1** Press the POSITION key.

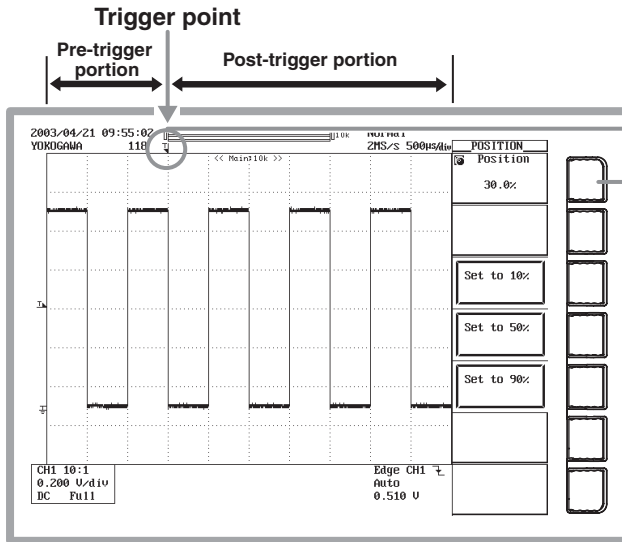

**Trigger position mark**

- 2** Turn the jog shuttle counterclockwise to set Position to 30.0%.  
The waveform shifts 2 div to the left.

To enter a setting of 10%, 50%, or 90%, press the corresponding soft key.

## Changing the Trigger Mode from Auto to Single

● ● ● ▶ User's manual section 6.1, "Selecting the Trigger Mode"

When a trigger activates in Single mode, the waveform display update stops once, and waveform acquisition stops. Single mode is useful for observing single-shot waveforms.

- 1** Press the MODE key.

When waveform acquisition stops, the status changes from "Running" to "Stopped."

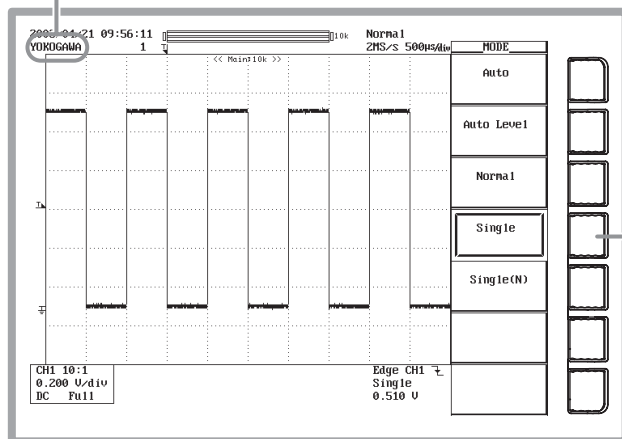

- 2** Select Single.

# Measuring a Waveform

This section explains how to use the vertical cursors to measure the voltage and period of the displayed waveform. In addition to cursor measurement, the DL7400 also has functions such as automatic measurement of waveform parameters and computation functions that are useful for taking pulse waveform and other types of measurements.

## Measuring Voltage with Vertical Cursors

●●●▶ User's manual section 10.5, "Making Cursor Measurements"

The voltage (Y-axis) and time (X-axis) at the position of the cursor is displayed in the lower part of the waveform display frame.

**CURSOR** — **1** Press the Cursor key.

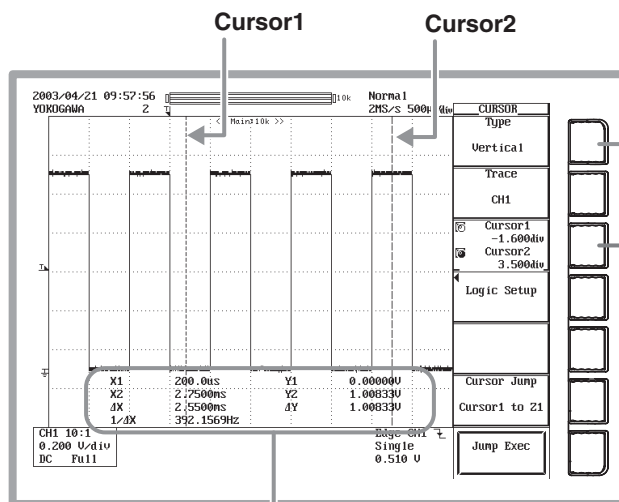

**2** Open the selection menu, then choose Vertical.

**3** Activate the jog shuttle on Cursor1.

**4** Turn the jog shuttle to move Cursor1.

**5** Move Cursor2 in the same manner.

If you activate the jog shuttle on both Cursor1 and Cursor2, you can move both cursors at the same time.

X1: X-axis value of Cursor1

X2: X-axis value of Cursor2

ΔX: difference in X-axis values of Cursor1 and Cursor2

1/ΔX: reciprocal of the difference in the X-axis values of Cursor1 and Cursor2

Y1: Y-axis value where Cursor1 intercepts the waveform

Y2: Y-axis value where Cursor2 intercepts the waveform

ΔY: difference in Y-axis values of Cursor1 and Cursor2

### Note

#### Cursor Types

##### When not displaying X-Y waveforms

**Horizontal cursor** Measures the Y-axis value at the cursor position.

**Vertical cursor** Measures the X and Y-axis values at the cursor position.

**Marker cursor** Measures the X and Y-axis values of the waveform. The marker cursor moves along the waveform. M1 to M4 (markers 1 through 4) can be set on separate waveforms.

**Angle cursor** Measurements can be made by converting the time axis values into angles. The zero point (position of reference cursor Ref1) and the end point (position of the reference cursor Ref2) are set on the X-axis and an angle (reference angle) is assigned to the width of Ref1 and Ref2. The positions of the two angle cursors (Cursor1 and Cursor2) can be converted into angles from the specified reference angle and measured.

##### When displaying X-Y waveforms

**Horizontal cursor** Measures the Y-axis value at the cursor position.

**Vertical cursor** Measures the X-axis value at the cursor position.

**Marker cursor** Measures the X and Y-axis values of the waveform. The marker cursor moves along the waveform.

# Zooming a Waveform along the Time Axis

This section describes how to zoom a portion of the displayed waveform along the time axis.

## Setting the Zoom Factor

●●●▶ [User's manual section 8.4, "Zooming the Waveform"](#)

You can display two zoomed waveform portions of the original (normal) waveform. The portion of the original waveform that is zoomed is shown by the "zoom box."

**1** Press the ZOOM key.

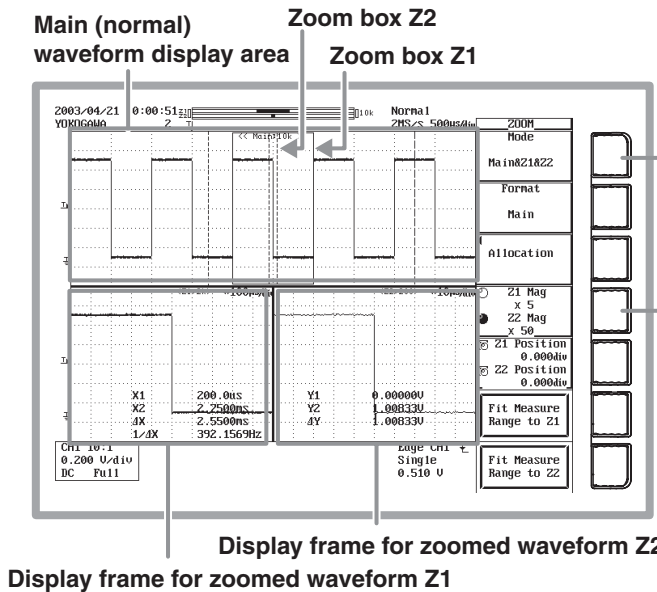

- 2** Select Main&Z1&Z2.
- 3** Activate the jog shuttle on Z1 Mag.
- 4** Turn the jog shuttle to select the zoom factor for Z1.
- 5** Set Z2 Mag in the same manner.  
If you activate the jog shuttle on both Z1 Mag and Z2 Mag, you can set both zoom factors at the same time.

## Changing the Zoom Position

●●●▶ [User's manual section 8.4, "Zooming the Waveform"](#)

You can move the zoom position while watching the zoom box.

**1** Press the ZOOM key.

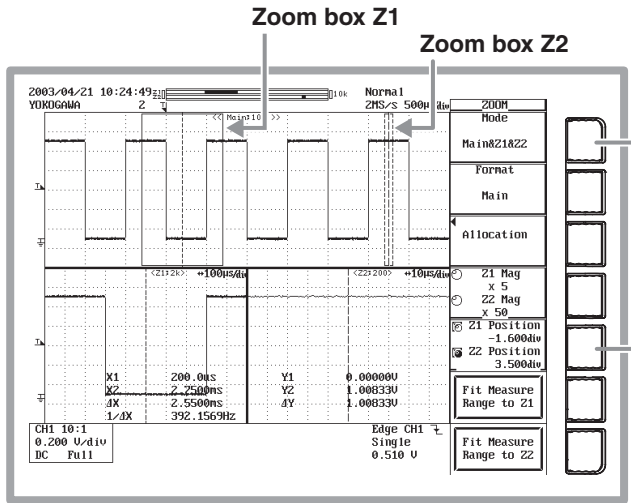

- 2** Select Main&Z1&Z2.
- 3** Activate the jog shuttle on Z1 Position.
- 4** Turn the jog shuttle to move zoom box Z1.
- 5** Set Z2 Position in the same manner.  
If you activate the jog shuttle on both Z1 Position and Z2 Position, you can set both zoom box positions at the same time.

# Printing and Saving a Waveform

This section describes how to print out the displayed waveform on the built-in printer (when the /B5 option is installed) or save it to a storage medium. You can also print waveforms to a USB or network printer (with the /C10 option installed). Or, if you specified other storage media (floppy disk or Zip disk at the time of purchase, or PC card), you can also save to the installed medium. You can also save to an external SCSI device, network drive (with the /C10 option installed), or USB storage.

## Printing Screen Images on the Built-In Printer

● ● ● ► User's manual section 11.2, "Printing Using the Built-In Printer"

You can print the waveform exactly as it appears on screen. Before printing, follow the procedure in section 11.1 of the user's manual to load roll paper into the built-in printer.

**PRINT** — 1 Press the PRINT key. Printing starts.

### Example of a Printout

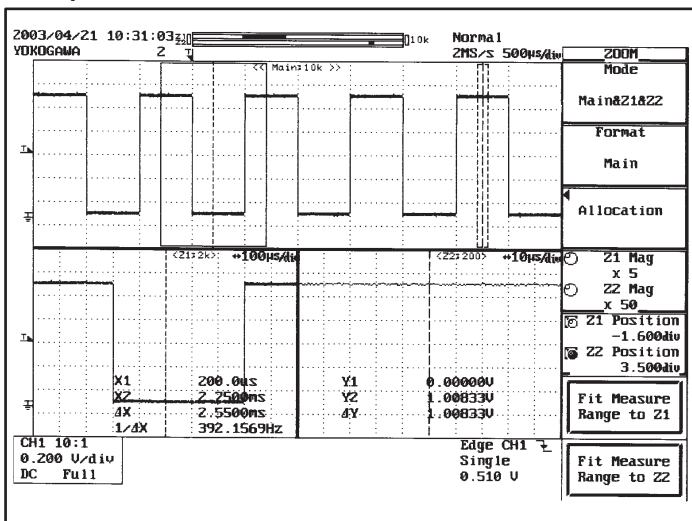

### Note

If you press the PRINT key after the SHIFT key, the PRINT menu appears. Settings using this menu are not required by this operation guide, but it may be useful to know that you can specify the print destination (built-in printer, USB printer, or network printer), the printing format, or comments (printed at the bottom of the screen image).

#### PRINT menu

PRINT
Print to
Built-in
Format
Normal
Long
Information
OFF
ON
Comment

## Saving Screen Image Data to a Storage Medium

● ● ● ► User's manual section 12.12, "Saving Screen Image Data"

You can save the waveform displayed on screen to a storage medium as image data.

Press the SHIFT key. The SHIFT indicator illuminates.

**SHIFT** + **IMAGE SAVE** — 1 After pressing the SHIFT key, press the IMAGE SAVE key.

**IMAGE SAVE** — 7 Press IMAGE SAVE again. The image is saved.

File Name	Size	Date	Attr
IFD			
IPC_Card			
NetWork			
0013			
0012			
0011	38574	2003/04/21 10:00	R:4

Drive name of the storage medium

- [FD] : Floppy disk
- [ZIP] : Zip disk
- [PC\_Card] : PC card
- [SCSI5] : SCSI device with the ID number set to 5
- [SCSI5-1] : Partition 1 of a SCSI device whose ID number is 5
- [NetWork] : Network drive
- [USB] : USB storage

2 Open the selection menu, then select a data format.

3 Select Color mode. (if something other than PostScript was selected in step 2)

4 Display the File List.

5 Turn the jog shuttle to select a save medium.

6 Press the SELECT key to enter the desired setting.

## Saving Waveform Data to a Storage Medium

● ● ● ► User's manual section 12.8, "Saving/Loading the Waveform Image Data"

You can save the waveform data displayed on screen to a storage medium. When the waveform is saved, its vertical axis, horizontal axis, and trigger settings are also saved.

**FILE** — 1 Press the FILE key.

2 Choose Waveform (waveform data).

3 Display the Save menu.

**Save menu**

4 Display the File List.

These settings not required by this operation guide, but you can enter them as needed.

4

5 Turn the jog shuttle to select a save medium.

6 Press the SELECT key to enter the desired setting.

Drive name of the storage medium  
See previous page.

7 Execute the save.

### Tips

#### Displaying thumbnails of the screen image data

● ● ● ► User's manual section 12.13, "Displaying Thumbnails of Saved Screen Image Data"

You can display thumbnail (miniature) images of the saved screen image data. Thumbnails make it easy to get a visual overview of what data has been saved.

Thumbnail

Thumbnail list display

From the FILE or IMAGE menu, select File List > File, then press the SELECT key.

From the IMAGE menu, press the Thumbnail soft key.